

Electrical Characteristics	
Cable or Adaptor	LMR400
Impedance	50 Ω
Frequency Range	DC - 6 GHz
V.S.W.R.	≦ 1.35
Working Voltage	≦ 1000 Vrms
Dielectric Withstanding Voltage	≦ 2500 Vrms

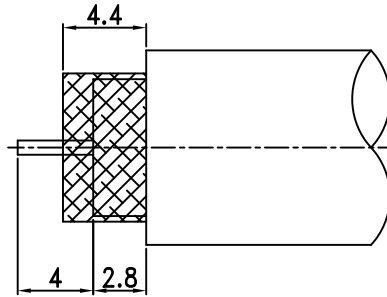

RECOMMENDED
CABLE STRIPPING DIM'S

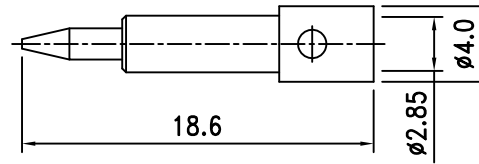
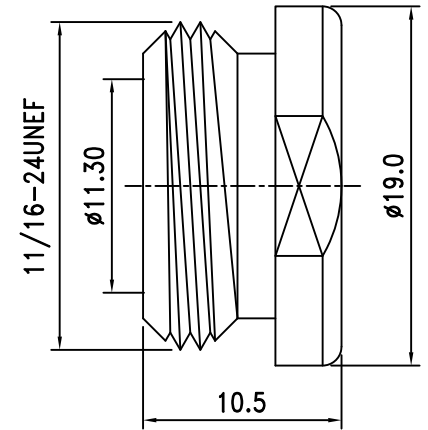
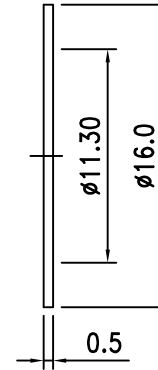
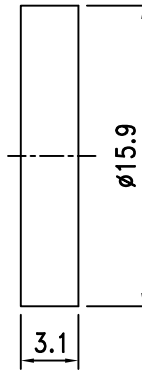
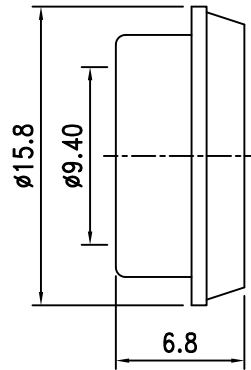
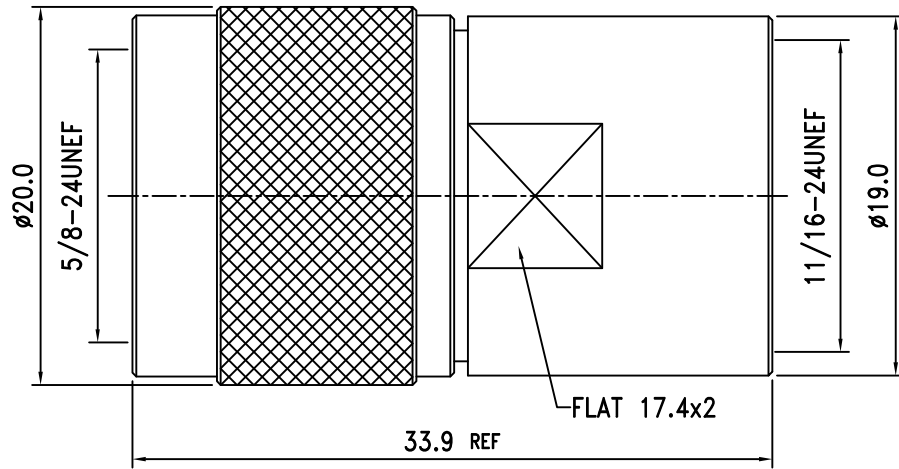

11.	Nut	Brass	1	Nickel
10.	Washet	Brass	1	Nickel
9.	Gasket	Silicone	1	Orange
8.	Braid Clamp	Brass	1	Nickel
7.	Shell	Brass	1	Nickel
6.	Gasket	Silicone	1	Red
5.	Retaining Ring	Brass	1	None
4.	Chassis	Brass	1	Nickel
3.	Insulation	PTFE	1	White
2.	Pin	Brass	1	Gold
1.	Body	Brass	1	Nickel
NO.	DESCRIPTION	MATERIAL	Q' TY	FINISH

繪圖DRAWN	SCALE	UNITS		夏尼有限公司	
Jenny	比例 10:4	單位 mm		SHINING PRECISION CO., LTD	
審核CHECKED	公差TOLERANCE		圖名	N-01T-TGN For Cable LMR400	
Peter	.X	±0.2	TITLE		
主管APPROVAL	.XX	±0.1	版次REV.	電腦圖檔CAD FILE	日期DATE
	.XXX	±0.05	A	C:/SHINING/N-PARTS/N-01T.DWG	2005.08.27
Peter	ANGLE	±0.5°			

